











MODEL: SWING 60/90 IX



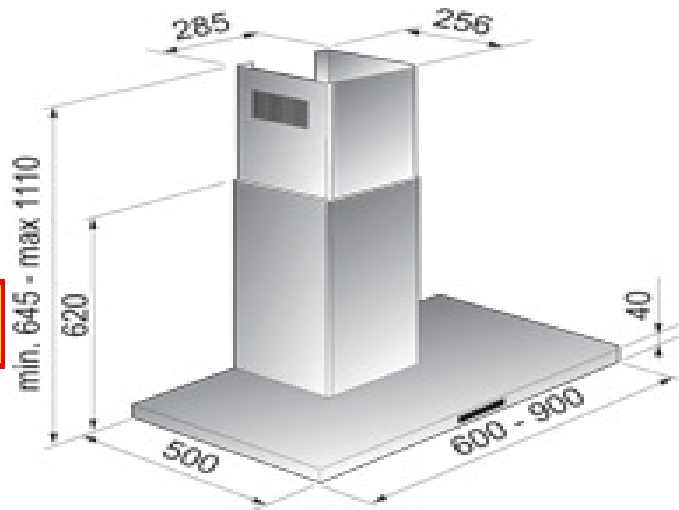



Dimension 600-900 mm

-  Inox
-  2 x 20 W Halogens
-  Aluminium panels
-  15cm extraction hole
-  15cm ducting pipe
-  Peripheral aspiration



Main control	
 Touch Control	 Timer Booster Clean Air Filter Saturation 4 Speeds
 Luminous soft touch	 Timer Booster Clean Air Filter Saturation 4 Speeds

Motor fan			
			
HC3	950**	436	53*
	628**		63**