

Oven, 60cm, 7 Function, Self-cleaning

Series 5 | Contemporary

Stainless Steel



With generous capacity and beautiful contemporary styling, this built-in oven will complement your kitchen design perfectly.

- 85L total capacity
- Seven oven functions including Pizza Bake
- Pyrolytic self-cleaning function breaks down food residue for an easy clean

DIMENSIONS

Height	598 mm
Width	596 mm
Depth	565 mm

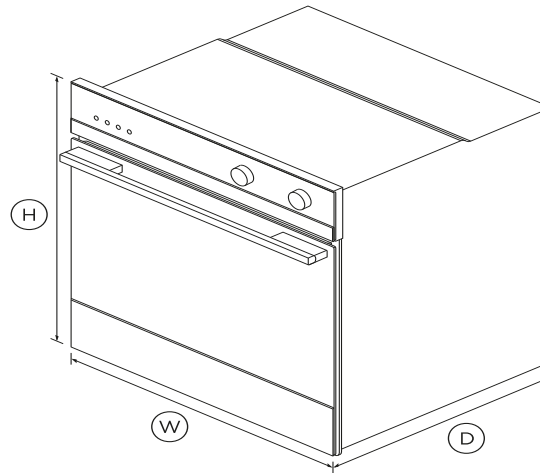

FEATURES & BENEFITS

Multi-function Flexibility

This built-in oven has seven functions with pre-set temperatures, including Bake, Fan Bake and Pizza Bake, allowing you to use a variety of cooking styles.

Generous capacity

With a generous sized internal cavity of 85L total capacity, you can create several dishes at once using multiple shelves.

Consistently hot

Ideal for multi-shelf cooking, this built-in oven features AeroTech™ - a technology that circulates heat evenly.

Pyrolytic self-cleaning

Pyrolytic self-clean breaks down food residue at a very high temperature, leaving a light ash that's easily removed with a damp cloth.

Refined styling

With sophisticated handle styling and black glass finish, our built-in ovens are designed to match the rest of Fisher & Paykel's kitchen appliance family.

Safe and sound

The CoolTouch door of this built-in oven is safe to touch from the outside. Sturdy, fully extendable shelves slide all the way out, reducing the need for you to reach inside.

SPECIFICATIONS

Accessories

Chromed shelf runners	•
Flat brushed baking tray	•
Flat wire shelf	•
Full extension sliding shelves	Optional (part 565048)
Roasting dish	•
Step down wire shelf	•
Telescopic sliding runners	•

Capacity

Shelf positions	6
Total capacity	85L
Usable capacity	72L

Cleaning

- Acid resistant graphite enamel
- Pyrolytic self-clean
- Removable oven door
- Removable oven door inner
- Removable shelf runners

Controls

- Audio feedback
- Automatic cooking/minute
- Automatic pre-set
- Behind glass capacitive touch
- Celsius/Fahrenheit
- Electronic clock
- Electronic oven control
- Interior light **2 x 25W (halogen)**
- Precise electronic temperature
- Sabbath mode

Functions

- Bake
- Fan bake
- Fan forced
- Fan grill
- Grill
- Number of functions **7**
- Pizza bake
- Pyrolytic self-clean

Performance

- AeroTech™ technology

- Automatic rapid pre-heat
- Grill power **3000W**
- Whisper quiet cooking

Power requirements

- Amperage **12.8 - 13.8A**
- Supply frequency **50Hz**
- Supply voltage **220 - 240V**

Product dimensions

- Depth **565 mm**
- Height **598 mm**
- Width **596 mm**

Safety

- Advanced cooling system
- Balanced oven door
- Catalytic venting system
- Control panel key lock
- CoolTouch door
- Non-tip shelves

Warranty

- Parts and labour **2 years**

SKU 81741

and specifications may change at any time. You should therefore check with Fisher & Paykel's Customer Care Centre to ensure this page correctly describes the model currently available. © Fisher & Paykel Appliances Ltd 2020

TEST The product dimensions and specifications in this page apply to the specific product and model. Under our policy of continuous improvement, these dimensions

Other product downloads available at fisherpaykel.com



User Guide



Service & Warranty Booklet



Installation Guide



Resources (zip)



A PEACE OF MIND SALE

24 Hours 7 Days a Week Customer Support

T 1300 650 590 **W**www.fisherpaykel.com