











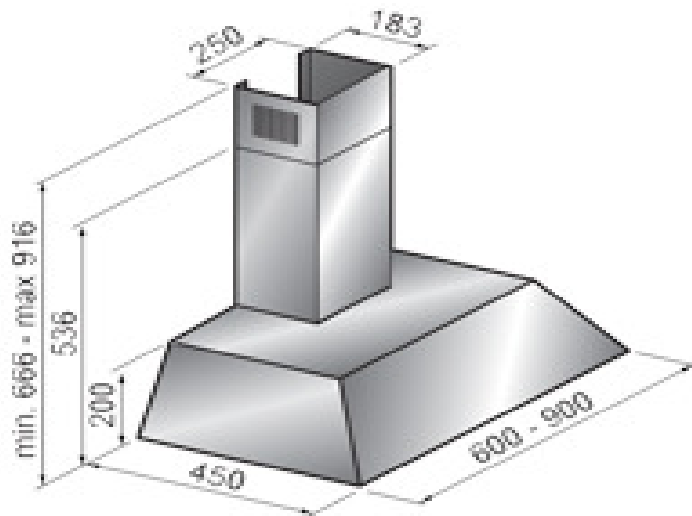

Dimension 600-900 mm

-  Inox
-  2 x 40 W Bulbs
-  Aluminium panels
-  150cm extracting hole
15cm ducting pipe



Main control	
	
Slider	3 Speeds

Motor fan			
			
JC1	400▪	228	50*
	363▪▪		61**