











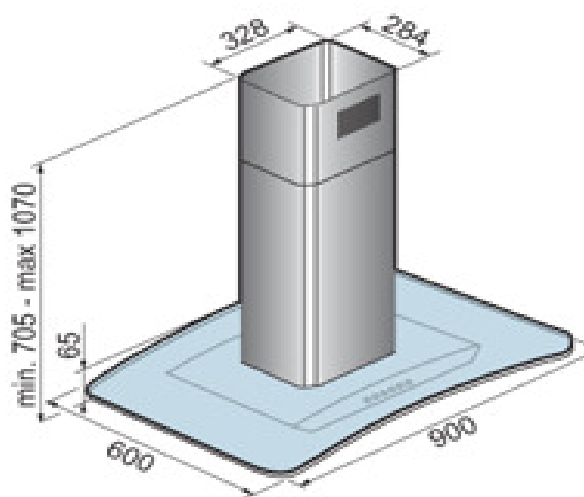

**Dimension 900 mm**

-  Inox
-  4 x 20 W Halogens
-  Aluminium panels
-  150cm extracting hole
-  15cm ducting pipe



Main control		
		
Luminous soft touch	Timer Booster AirFilter Saturation 4Speeds	
Push buttons	<a href="#">3 Speeds</a>	

Motor fan			
			
HC3	950*	436	53*
	628**		63**