

*Fisher & Paykel*

Compact oven  
OB60N8DTX models

**Installation instructions  
and User guide**

NZ AU GB IE



<b>Safety and warnings</b>	<b>3</b>
<b>Installation instructions</b>	
Choice of location	7
Fitting	7
Electrical specifications	8
Electrical connection	9
<b>Introduction to your oven</b>	<b>11</b>
<b>Control panel</b>	<b>13</b>
<b>Display</b>	<b>14</b>
<b>Using your appliance</b>	
Setting and adjusting the time	15
Contrast adjustment	15
Timer function	15
Child safety	16
Operation	16
Instant cooking	17
Programmed cooking	18
Recipe function	20
<b>Oven cooking modes</b>	<b>22</b>
<b>Care and cleaning</b>	<b>24</b>
<b>Troubleshooting</b>	<b>27</b>
<b>Warranty and service</b>	<b>28</b>

## ***Important!***

### ***SAVE THESE INSTRUCTIONS***

*The models shown in this User Guide may not be available in all markets and are subject to change at any time. For current details about model and specification availability in your country, please visit our local website listed on the back cover or contact your local Fisher & Paykel dealer.*

***Important!***

*Keep this user guide with your appliance. If the appliance is ever sold or transferred to another person, ensure that the new owner receives the user guide. Please become familiar with these recommendations before installing and using your oven. They were written for your safety and the safety of others.*

## **IMPORTANT SAFETY INSTRUCTIONS**

- This appliance is not designed to be used by people (including children) with reduced physical, sensorial or mental capacity or people lacking in experience or knowledge, except if they have the benefit, through the intermediary of a person responsible for their safety, of preliminary supervision or instruction concerning the use of the appliance.***
- This oven was designed for use by private persons in their homes. It is intended solely for cooking foodstuffs. This oven does not contain any asbestos-based components.***
- Please make sure children do not play with the appliance.***
- When you receive the appliance, unpack it or have it unpacked immediately. Give it an overall inspection. Make note of any concerns or reservations on the delivery slip and make sure to keep a copy of this form.***

## **IMPORTANT SAFETY INSTRUCTIONS**

- *Your appliance is intended for standard household use. Do not use it for commercial or industrial purposes or for any other purpose than that for which it was designed.*
- *Do not modify or attempt to modify any of the characteristics of this appliance. This would be dangerous to your safety.*
- ***WARNING:** accessible parts may be hot when in use. It is advisable to keep small children away from the appliance.*
- *Never pull your appliance by the door handle.*
- *Before using your oven for the first time, heat it while empty for approximately 15 minutes. Make sure that the room is sufficiently ventilated. You may notice a particular odour, or a small release of smoke. All of this is normal.*
- ***WARNING:** accessible parts may become hot when the grill is used. It is advisable to keep children away from the appliance.*
- *When in use, the appliance becomes hot. Be careful not to touch the heating elements located inside the oven.*
- *Installation should only be performed by installers and qualified technicians.*

## **IMPORTANT SAFETY INSTRUCTIONS**

- *When placing dishes inside or removing them from the oven, do not place your hands close to the upper heating elements, use heat-protective kitchen gloves.*
- *At the end of cooking, do not pick up dishes (grills, rotisserie...) with bare hands.*
- *Never place aluminium foil directly in contact with the oven shelf (see the chapter on oven description), the accumulated heat may cause deterioration of the enamel.*
- *Do not place heavy weights on the open oven door, and make sure that children are able neither to climb nor sit on it.*
- *The oven must be turned off when cleaning inside the oven.*
- *Children of less than 8 years old must be kept away from the appliance unless continuously supervised. This appliance can be used by children aged from 8 years and above, and persons with reduced physical, sensory or mental capabilities or lack of experience and knowledge, if they have been given supervision or instruction concerning the use of the appliance in a safe way and they understand the hazards involved. Cleaning and user maintenance shall not be done by children without supervision.*

## IMPORTANT SAFETY INSTRUCTIONS

- *Additionally to the accessories supplied with your oven, only use dishes which resist high temperatures (follow the manufacturer's instructions).*
- *After using your oven, make sure that all the controls are in their stop position.*
- *Do not use your oven as a larder or to store any items after use.*
- *Never use steam or high-pressure devices to clean the oven (electrical safety requirement).*
- *All types of cooking are done with the door closed.*
- *Caution: The appliance must be able to be disconnected from the mains supply network after installation. Disconnection can be enabled by ensuring that there is an accessible power plug or by incorporating a switch into the fixed wiring in compliance with the installation rules.*
- *If the power cable is damaged, it should be replaced by the manufacturer, its after-sales service department or a similarly qualified person to avoid danger.*
- *(According to model) For your safety, your oven is equipped with an AUTOMATIC STOP, if you forget to turn off your oven by mistake. After 23 hours and 30 minutes of continuous use, the AS (Automatic Stop) feature will be activated and your oven will turn itself off. AS or Auto Stop will be displayed instead of the time and a series of successive beeps will be emitted for a short time.*

## IMPORTANT SAFETY INSTRUCTIONS

### Caring for the environment

- *This appliance's packing materials are recyclable. Recycle them and play a role in protecting the environment by depositing them in municipal containers provided for this purpose.*
- *Your appliance also contains many recyclable materials. It is therefore marked with this logo to indicate that used appliances must not be mixed with other waste. Recycling of the appliances organised by your manufacturer will thus be undertaken in optimum conditions, in accordance with European directive EC/2002/96 relating to electrical and electronic equipment waste. Consult your local authority or your retailer to find the drop-off points for used appliances that is nearest to your home.*
- *We thank you for your help in protecting the environment.*





Two installation options:

Option 'A' - oven only (overall height 457 mm)

Option 'B' - oven + lower trim kit accessory  
(overall height 478 mm)

Note: If you are installing an appliance directly over another, you have the option of using the supplied black metal shelf cover to conceal the shelf front that would be visible between the two appliances. This needs to be fitted before the lower trim kit and/or appliance is installed. Refer to the instructions packed with the shelf cover accessory kit.

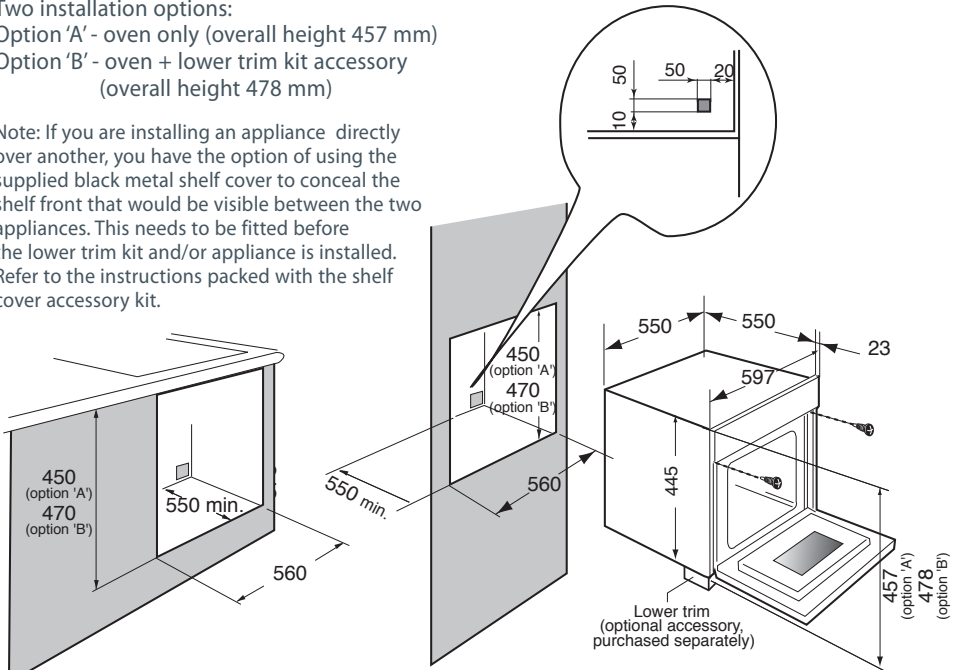

## Important!

*If you choose Installation option B, you will need to install the lower trim kit BEFORE you install the appliance. Refer to the instructions packed with the lower trim kit.*

## Choice of location

The above diagrams determine the dimensions of a cabinet that will be able to hold your oven. The oven can be installed under a work top or in a column of cabinetry (open or closed) having the appropriate dimensions for built-in installation (see diagram above).

Your oven has optimised air circulation that allows it to achieve remarkable cooking and cleaning results if the following guidelines are followed :

- Centre the oven in the cabinet so as to guarantee a minimum distance of 10mm between the appliance and the neighbouring cabinet.
- The material or coating of the cabinet must be heat-resistant.
- For greater stability, attach the oven in the cabinet with two screws through the holes provided for this purpose on either side of the front inner panel.

## Fitting

To do this :

- 1 Drill a hole in the cabinet panel to avoid splitting the wood.
- 2 Attach the oven with the two screws.

Note: To be certain that you have properly installed your appliance, do not hesitate to contact a household appliance specialist.

## Installation alignment

The diagrams below explain how to achieve the correct and proper alignment of visual elements of the product should it be necessary. This also allows you to align visual elements across products if this product is installed alongside other companion products.

### Inspect the product to check if the gaps are correct

- There should be a minimum 5 mm gap at the base of the product (ie from the bottom of the door glass to the shelf). The product can be raised or lowered to achieve this gap by adjusting the two small feet at the front of the product with a 7 mm spanner.

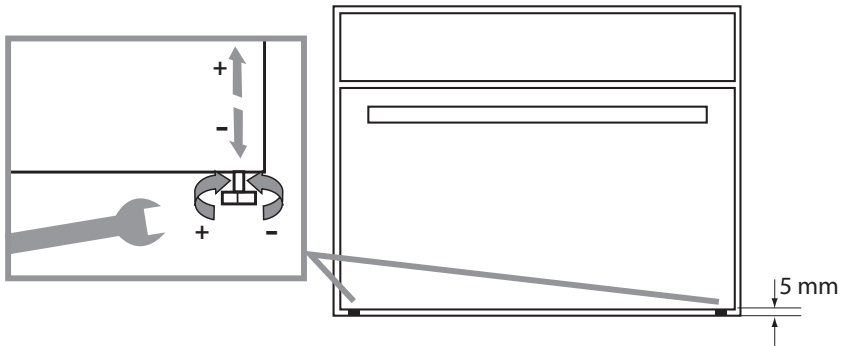

## Electrical specifications

- Electrical connection rating: 3.135 kW
- Voltage/frequency: 220-240 V/ 50 Hz
- Current: 16 A

## Electrical connection

The appliance must be fitted correctly to guarantee electrical safety. During fitting and maintenance operations, the appliance must be disconnected from the electrical grid; fuses must be switched off or removed. The electrical connections are made before the appliance is installed in its housing. Ensure that:

- the electrical installation has sufficient voltage,
- the electrical wires are in good condition,
- the diameter of the wires complies with the installation requirements.
- the oven is connected to a single phase 220-240 V 50 Hz supply using a 1.5 mm<sup>2</sup> cable and connected to earth. The supply must be protected by a suitably rated circuit breaker in accordance with the installation regulations.
- a suitable isolating switch providing full disconnection from the mains power supply is incorporated in the permanent wiring, mounted and positioned to comply with the local wiring rules and regulations. The isolating switch must be of an approved type and provide a 3 mm air gap contact separation in all poles (or in all active [phase] conductors if the local wiring rules allow for this variation of the requirements)
- the isolating switch will be easily accessible to the customer with the oven installed.

## ***Important!***

*The safety wire (green-yellow) is connected to the appliance's terminal and must be connected to the earth terminal of the electrical set-up.*

*If the power cable is damaged, it should be replaced by the manufacturer, its after-sales service department or a similarly qualified person to avoid danger.*

*We cannot be held responsible for any accident resulting from inexistent, defective or incorrect earthing.*

*If the electrical installation in your residence requires any changes in order to hook up your appliance, call upon a professional electrician.*

*If the oven malfunctions in any way, disconnect it from the power supply or remove the fuse corresponding to the sector where the oven is hooked up.*



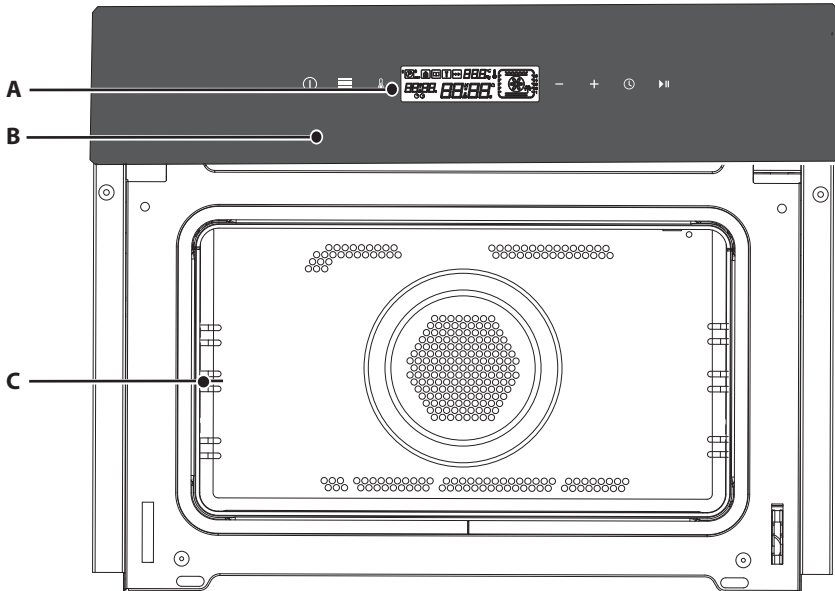

- A** Display
- B** Controls
- C** Wire shelf supports

## Accessories supplied

### Shelf

The shelf can be used to hold all dishes and moulds containing foodstuffs to be cooked or browned.

It can be used for barbecues  
(to be placed directly on the shelf).

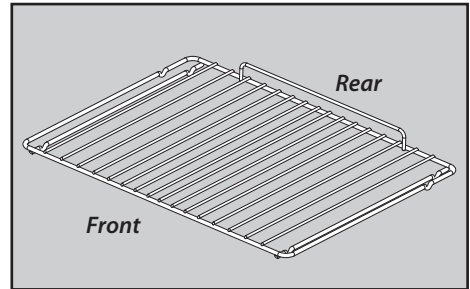

*Shelf*

### Enamel tray

When inserted in the supports under the shelf, it collects juice and fat from grilling, and can be used half-filled with water as a double-boiler.

Avoid placing roasts or meat directly in the tray because this is certain to cause significant spattering on the oven walls.

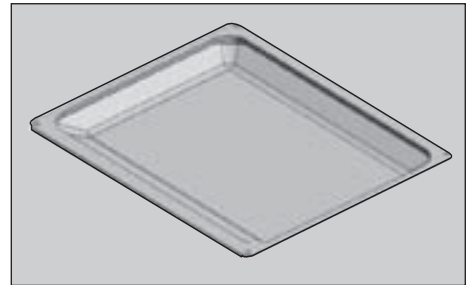

*Enamel tray*



- A** The Start/Stop button allows you to start a programme, and suspend or stop a programme underway.
- B** The Recipe Function button lets you choose a food category for the automatic function.
- C** The Temperature button lets you adjust the temperature.
- D** The “Minus” and “Plus” buttons let you choose the programme type and increase and decrease the time, the cooking time and the temperature.
- E** The Clock button lets you set the time and the cooking time.
- F** The Start/Pause button lets you start or pause an operation and lock the control panel.

## 14 Display

The display helps you to programme the various settings Time, Cooking time, Food weight (grammes), Recipe Function.

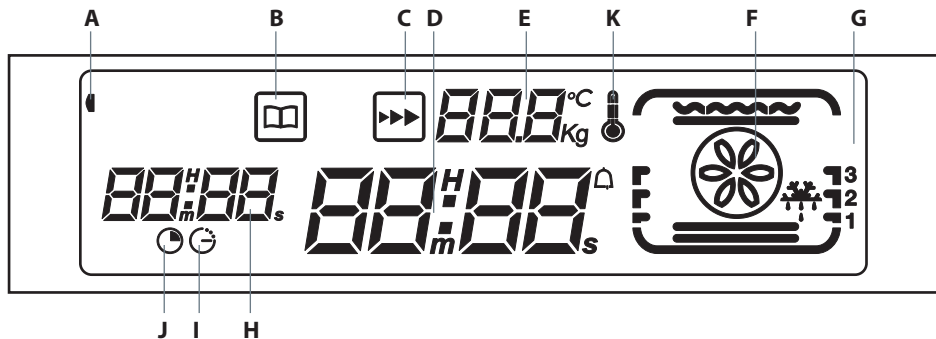

- |          |                         |          |                            |
|----------|-------------------------|----------|----------------------------|
| <b>A</b> | Child safety            | <b>F</b> | Cooking modes              |
| <b>B</b> | Recipe function         | <b>G</b> | Shelf support indicator    |
| <b>C</b> | Fast pre-heat function  | <b>H</b> | Programme time             |
| <b>D</b> | Time                    | <b>I</b> | End of cooking indicator   |
| <b>E</b> | Temperature/food weight | <b>J</b> | Cooking time indicator     |
|          |                         | <b>K</b> | Temperature rise indicator |



## Setting and adjusting the time

After connecting your appliance or after an extended power outage, "12:00" will flash on the display.



### To set the time on the clock Display

Set the time using the + and - buttons, then confirm by pressing ►||



### To change the time Display

Press the Ⓛ button then the Ⓛ button twice. The time flashes.

Set the new time (e.g. 7:30) by using the + and - buttons.

Confirm by pressing ►||.

There is a beep to confirm that the new time has been set.



## Contrast adjustment

### Programming

Press the Ⓛ button, then hold down Ⓛ for a few seconds until "CO" is displayed.

Adjust the contrast using the + and - buttons and confirm by pressing the ►|| button.



## Timer function

### Programming

You can programme the "Timer" function on your oven.

Press the Ⓛ button followed by the Ⓛ button.

Adjust the programme time using the + and - buttons, e.g. 1 minute. Confirm by pressing ►||.



The display shows the time again but the countdown starts.

## 16 Using your appliance

### Child safety

You can activate the “CHILD SAFETY” function to prevent unauthorised use of your oven.

#### Programming

Press the ►|| button for 3 seconds. There are two beeps to confirm that your oven is temporarily locked.

The 🔒 symbol appears in the top left-hand corner of the display. No programmes are available.



To cancel:

Follow the same procedure:

Press the ►|| button for 3 seconds. The 🔒 symbol disappears and the clock is displayed. Two beeps are sounded to confirm the procedure.

### Operation

Your appliance is now connected and the correct time is set.

Open the door using the handle. Place the food inside, then close the door.

If the door is not closed properly, the appliance will not work.

Opening the door during operation does not cancel the current programme but just interrupts it.

To restart the oven, close the door.

Press the ►|| button when the door is closed to interrupt the programme and press it again to resume cooking.

To cancel a programme, press the Ⓛ button.

There are three beeps to indicate the end of each programme and the time is again displayed in the display panel.

## Instant cooking

### Programming

The programmer should display only the time. It should not be flashing.

Press the **ⓘ** button, then select your cooking programme using the + and - buttons.

Example: TRADITIONAL, shelf support 1 or 2, 200 °C recommended.

Place your dish in the oven based on the recommendation indicated in the display.

– Confirm by pressing **▶||**.

The oven begins heating.

Your oven recommends the optimum temperature for the chosen cooking mode.

It is, however, possible to adjust the temperature.

After you have chosen your cooking programme, press the **🌡** button and adjust the temperature using the + and - buttons, then confirm by pressing the **▶||** button.

Example: 220 °C



The temperature rise indicator is activated and indicates the temperature increase in the oven. A series of beeps will sound when the oven reaches the selected temperature.

To stop cooking, press the **ⓘ** button.

### ***Important!***

- *After a cooking cycle, the cooling fan continues to operate for a period of time in order to ensure optimum oven reliability.*
- *All types of cooking are done with the door closed.*

## Programmed cooking

### Cooking with immediate start and programmed duration

Press the **ⓘ** button. Select the desired cooking mode and adjust the temperature (see instant cooking section), then confirm by pressing the **▶||** button.

- Then press the **ⓘ** button and the cooking time indicator flashes.

You can then set a cooking time.

Press the **+** or **-** buttons to set the desired time.

Example: 30 min cooking time.

- Confirm by pressing **▶||** .



The cooking time display stops flashing.

- Confirm again by pressing the **▶||** button..

Your oven starts.

The countdown begins immediately.



After these steps, the oven heats up:

A series of beeps will sound when the oven reaches the selected temperature.

At the end of cooking (end of programmed time),

- the oven stops,

- the cooking time indicator and 0:00 flash

- a series of beeps sounds for a few minutes.

The beeps can be stopped by pressing the **ⓘ** button.

## Programmed cooking

### Cooking with delayed start and chosen cooking end time

Press the **ⓘ** button. Select the desired cooking mode and adjust the temperature, then confirm by pressing the **▶||** button.

- Then press the **🕒** button to set the cooking time.

- Press the **+** or **-** buttons to set the desired time.

Confirm by pressing **▶||**.

- Press the **🕒** button again.

The cooking end time flashes to indicate that it can now be set.

- Press the **+** or **-** button to set the desired cooking end time.

Example: end of cooking at 18:00.

Confirm by pressing **▶||**.



The cooking end time display stops flashing.

After these steps, the oven heating is delayed so that cooking ends at 18:00.

At the end of cooking (end of programmed time),

- the oven stops,

- the cooking time indicator and 0:00 flash.

- a series of beeps sounds for a few minutes.

The beeps can be stopped by pressing the **ⓘ** button.

The display returns to the time of day.

The light inside the oven comes on when cooking starts and goes out at the end of cooking.

## Recipe function

With the "Recipe" function, the cooking time and mode are automatically programmed based on the food type and weight.

P01	Stuffed tomatoes
P02	Grilled red peppers
P03	Grilled hake or cod
P04	Salmon in beer
P05	Trout with mushrooms
P06	Langoustines
P07	Roast pork
P08	Roast lamb
P09	Roast veal
P10	Roast rabbit
P11	Roast chicken
P12	Traditional biscuits
P13	"Madeleines" biscuits
P14	Egg flan
P15	Bread: prebaked baguettes

### Programming automatic cooking time based on food weight

Press the  button followed by the  button to select the recipe function. P01 flashes on the display.

Choose your programme (P01 to P15) depending on the type of food you want to cook by pressing the + or - button, then confirm by pressing the  button.  
Example: Salmon (P04)

The minimum weight flashes on the display (here 1.5 kg).



Adjust the weight (for example 1.6 kg) using the + and - buttons. Confirm by pressing .

The necessary programme time is calculated automatically and this time is depicted on the display by 2 flashing squares.

This cooking time can be changed by pressing the + and - buttons. See table below:

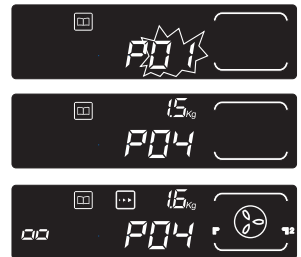

## Recipe function



The cooking time is reduced by 15% compared to the suggested cooking time.



This is the suggested cooking time.



The cooking time is increased by 15% compared to the suggested cooking time.



The cooking time is increased by 30% compared to the suggested cooking time.

Example: You want to increase the cooking time by 15% compared to the initial time, i.e. **00 0**

Press the + button and then confirm by pressing the ▶|| button.

The time calculated is then 12 minutes at a temperature of 218°C.

In this recipe, the Fast pre-heat symbol (preheating) flashes and the cooking time countdown starts after preheating is complete.

Note: During cooking, pressing  displays the number of your recipe and the cooking time depicted by the number of squares.

After a few seconds, the display once again displays the temperature and the cooking time.





### Defrosting

*(recommended temperature 35°C min 35°C max 75°C)*

- Dishes are defrosted using a limited amount of heat and the fan.
- Perfect for delicate dishes (fruit tart, custard pie, etc.).
- Meat, buns, etc. are defrosted at 50 °C (meat should be placed under the grill with a dish underneath to catch drips from the defrosting which are not edible).



### Traditional\*

*(recommended temperature 200°C min 35°C max 250°C)*

- Cooking is controlled by the upper and lower heating elements.
- Preheating recommended.



### Fan assisted bottom element

*(recommended temperature 180°C min 75°C max 250°C)*

- Cooking is controlled by the bottom element combined with a slight dose of the grill and the fan.
- Place the shelf on the lowest shelf support.
- Recommended for moist dishes (quiches, juicy fruit tarts, etc.). The crust will be thoroughly cooked on the bottom. Recommended for dishes that rise (cakes, brioche, kugelhupf, etc.) and for soufflés that will not be hampered by a crust formed on the top..



### Medium grill

*(recommended temperature 210°C min 100°C max 275°C)*

- Cooking is controlled by the upper element.
- It is recommended for grilling chops, sausages, toast or prawns placed on the grill.



### High-power grill

*(recommended temperature 230°C min 100°C max 275°C)*

- Cooking is controlled by the upper element.
- It is recommended for grilling chops, sausages, toast or prawns placed on the grill.

## ***Important!***

*All types of cooking are done with the door closed.*

\* Programme(s) used to obtain the results indicated on the energy label in accordance with European standard EN 50304 and European Directive 2002/40/EC.





## Fan assisted grill

*(recommended temperature 190°C min 100°C max 250°C)*

- Cooking is controlled simultaneously by the upper element and by the fan.
- Preheating is unnecessary. Succulent roasts and poultry that are crisp all over.
- Slide the enamel tray onto the bottom shelf support.
- Recommended for all roasted poultry or meat, for sealing and thoroughly cooking a leg or a rib of beef. To retain the moist texture of fish steaks.



## Turbo plus\*

*(recommended temperature 190°C min 35°C max 250°C)*

- Cooking is controlled by the heating element located at the back of the oven and by the fan.
- Quick heat: some dishes can be placed in the oven while it is still cold.
- Recommended for keeping white meat, fish and vegetables moist.



## Traditional fan assisted

*(recommended temperature 180°C min 35°C max 220°C)*

- Cooking is controlled by the upper and lower heating elements and by the fan.

## ***Important!***

*All types of cooking are done with the door closed.*

\* Programme(s) used to obtain the results indicated on the energy label in accordance with European standard EN 50304 and European Directive 2002/40/EC.

### Cleaning the outer surfaces

To clean both the electronic programmer window and the oven door, use a window washing product applied to a soft cloth. Do not use abrasive creams or scouring sponges.

### Cleaning the inside of the door

#### Disassembling the door

Before removing the glass window,

- Open the door completely and block it open using the two red stops. They are supplied with your oven in the plastic pack.

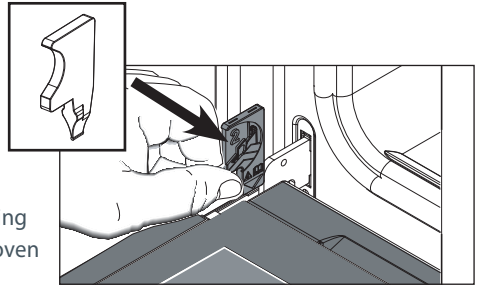

- To remove the frame and glass assembly, proceed as follows:  
Insert the two red stops in the A slots designed for this.

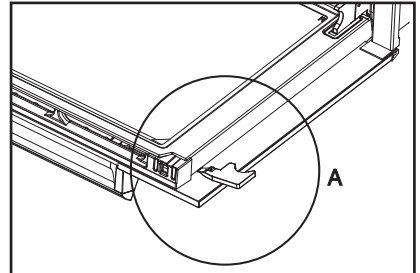

- Lever the assembly to detach the frame and the glass.

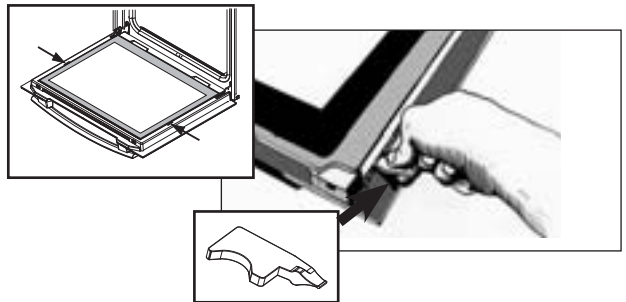

- Remove the frame and the glass.



- Remove all the door's interior windows by rotating them.  
This assembly comprises 2 glass windows, the 1st of which has 2 rubber stops on the 2 front corners.
- Clean the glass using a soft sponge and washing-up liquid.
- Do not soak the window in water.
- Do not use abrasive creams or scouring sponges. Rinse with clean water and dry off with a lint-free wiper.

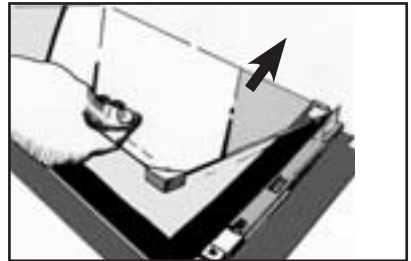

- After cleaning, replace the 1st glass in the door.
- Reposition the 2 black rubber stops on the front corners of the 2nd glass, making sure that the it says:  
at top left: L  
at top right: R

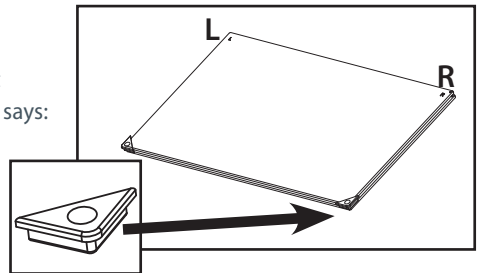

Then replace the door and the 2nd glass, positioning it on the first.

### ***Important!***

*Do not use abrasive cleaning products or hard metallic scrapers for cleaning the oven's glass door, as they could scuff the surface and cause the glass to shatter.*

## 26 Care and cleaning

Place the glass frame assembly back in the door.



- Take care to correctly slot the frame under the spigot next to the hinge.

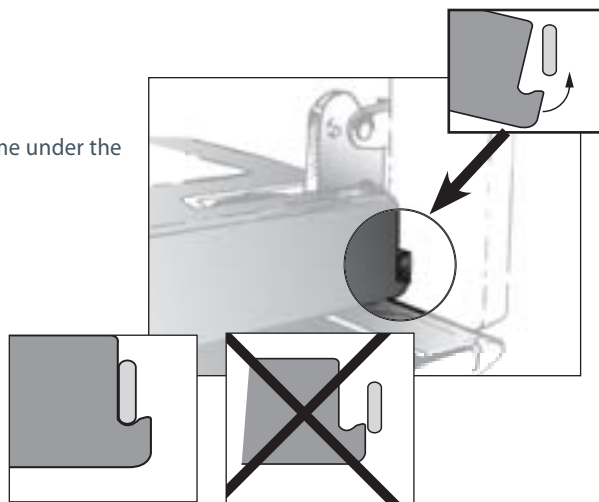

- Attach the frame by tightening it with the door.

Do not press on the frame alone.  
Your appliance can now be used again.

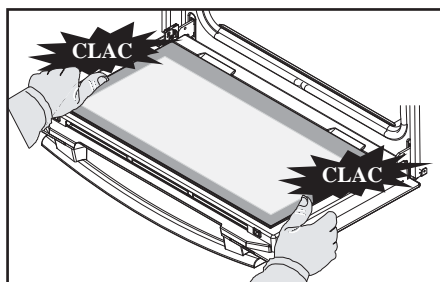

### **Important!**

*Do not use abrasive cleaning products or hard metallic scrapers for cleaning the oven's glass door, as they could scuff the surface and cause the glass to shatter.*

If you have a doubt about the correct functioning of your oven, this does not necessarily mean that there is a malfunction. In any event, check the following items:

Problem	Possible causes	What to do
The oven is not heating	The oven is not connected to the power supply. - Your fuse is out of order. - The selected temperature is too low.	Make sure that the oven is connected to the power supply. Replace the fuse in your electrical set-up and check its capacity (16A). Increase the selected temperature.
The oven light is not working.	The light is out of order.	Call Customer Care.
Your oven starts beeping.	During cooking.  - At the end of a cooking cycle.	The recommended temperature of your choice has been reached.  - Your programmed cooking cycle is finished.
The cooling fan continues to operate after the oven stops.	- The fan should work for a maximum of one hour after cooking, or when the oven temperature is greater than 125°C.	If it does not stop after 1 hour, open the oven door to accelerate the cooling down of the oven Call Customer Care.

## ***Important!***

*Repairs to your appliance should only be performed by professionals. Non-standard repairs can be a source of danger for the user.*

### **Error codes**

<i>F01</i>	Probe error (oven centre)
<i>F02</i>	Overheated oven
<i>F05</i>	Other cooking problems
<i>F10</i>	Information: Power cut during cooking
<i>AUTO</i>	Auto Stop: cooking time too long

# 28 Warranty and service

## Before you call for service or assistance ...

Check the things you can do yourself. Refer to the 'Installation instructions', and your 'User guide' and check that:

- 1 your product is correctly installed
- 2 you are familiar with its normal operation.

If after checking these points you still need assistance, please see you 'Service and warranty' booklet for warranty information and Customer Care contact details, or contact us through our website listed on the back cover.

---

**Fisher & Paykel Appliances**

**Model no** .....

**Serial no.** .....

*Copy this from the serial label of your oven.  
The label is located on the inside frame bottom right.*

**Date of purchase**  
.....

**Contact details**  
.....

**Dealer name**  
.....

---



[www.fisherpaykel.com](http://www.fisherpaykel.com)

***Fisher & Paykel***

Copyright © Fisher & Paykel 2013. All rights reserved.

The product specifications in this booklet apply to the specific products and models described at the date of issue. Under our policy of continuous product improvement, these specifications may change at any time. You should therefore check with your Dealer to ensure this booklet correctly describes the product currently available.