







# elitair *ISOLA SWING 90 IX*





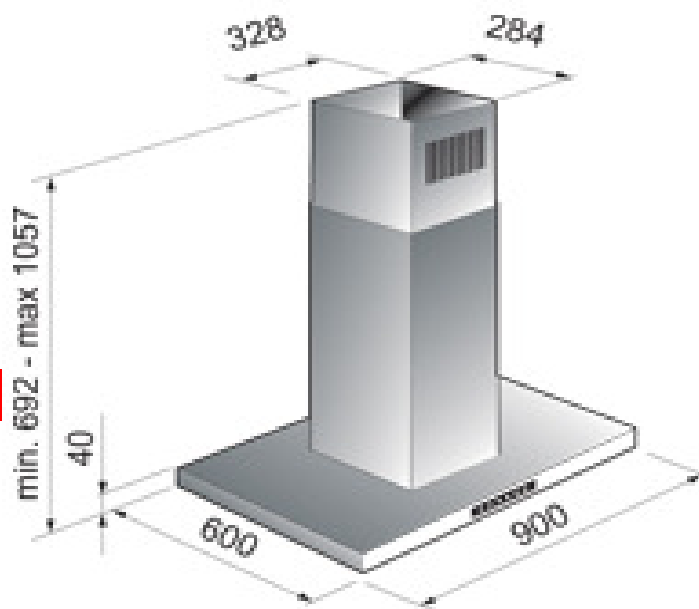

**Dimension 900 mm**

-  Inox
-  4 x 20 W Halogens
-  Aluminium panels
-  15cm extraction hole/ 15cm ducting pipe
-  Perimetral aspiration



Main control	
	
Touch Control	TimerBoosterC lean AirFilter Saturation 4Speeds
Luminous soft touch	TimerBoosterC lean AirFilter Saturation4 Speeds

Motor fan			
			
HC3	950	436	53*
	628**		63**