















FIM ISLAND HOOD

MODEL: 1010 090/120/150



- | | | | |
|---|---|---|---------------------|
|  | ISOLA |  | DUCT OUT |
|  | 120cm X 60cm |  | HIGH - HC3 |
|  | INOX |  | 1000 m ³ |
|  | 8X1W LED'S |  | 520 |
|  | STAINLESS STEEL FILTER |  | I: 53 |
|  | EXTRACTION HOLE 15cm Ø DUCTING PIPE 15cm Ø |  | III: 56-61 |
|  | TOUCH CONTROL |  | 300W |

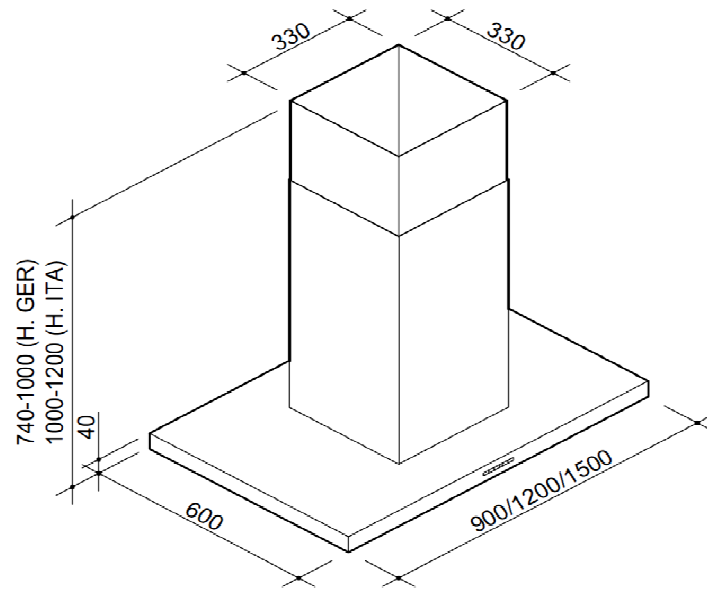

ΣΗΜΑΝΤΙΚΟ: Σε περίπτωση που η οροφή (ταβάνι) είναι ψηλή και ο αποσμητήρας δεν μπορεί να επεκταθεί αρκετά για να μπει στη σωστή διάσταση πάνω από τις εστίες, τότε επεκτατική βάση θα πρέπει να τοποθετηθεί μεταξύ της οροφής και της βάσης του αποσμητήρα. Κόστος περίπου 100€ ανάλογα με τα δεδομένα της κάθε περίπτωσης.